

±16.5kV ESD Protected, +125°C, 3.0V to 5.5V, SOT-23/TDFN Packaged, Low Power, RS-485/RS-422 Transmitters

The Intersil ISL3293E, ISL3294E, ISL3295E, ISL3296E, ISL3297E, ISL3298E are ±16.5kV HBM ESD Protected (7kV IEC61000 contact), 3.0V to 5.5V powered, single transmitters for balanced communication using the RS-485 and RS-422 standards. These drivers have very low bus currents (±40mA), so they present less than a “1/8 unit load” to the RS-485 bus. This allows more than 256 transmitters on the network without violating the RS-485 specification’s 32 unit load maximum, and without using repeaters.

Hot Plug circuitry ensures that the Tx outputs remain in a high impedance state while the power supply stabilizes.

The ISL3293E, ISL3294E, ISL3296E, ISL3297E utilize slew rate limited drivers which reduce EMI, and minimize reflections from improperly terminated transmission lines, or from unterminated stubs in multidrop and multipoint applications. Drivers on the ISL3295E and ISL3298E are not limited, so they can achieve the 20Mbps data rate. All versions are offered in Industrial and Extended Industrial (-40°C to +125°C) temperature ranges.

A 26% smaller footprint is available with the ISL3296E, ISL3297E, ISL3298E’s TDFN package. These devices also feature a logic supply pin (V_L) that sets the switching points of the DE and DI inputs to be compatible with a lower supply voltage in mixed voltage systems.

For companion single RS-485 receivers in micro packages, please see the ISL3280E, ISL3281E, ISL3282E, ISL3283E, ISL3284E data sheet.

Features

- High ESD Protection on RS-485 Outputs . . . ±16.5kV HBM
 - IEC61000-4-2 Contact Test Method ±7kV
 - Class 3 ESD Level on all Other Pins >8kV HBM
- Specified for +125°C Operation (V_{CC} ≤ 3.6V Only)
- Logic Supply Pin (V_L) Eases Operation in Mixed Supply Systems (ISL3296E through ISL3298E Only)
- Hot Plug - Tx Outputs Remain Three-state During Power-up
- Low Tx Leakage Allows >256 Devices on the Bus
- High Data Rates up to 20Mbps
- Low Quiescent Supply Current 150µA (Max)
 - Very Low Shutdown Supply Current 1µA (Max)
- -7V to +12V Common Mode Output Voltage Range (V_{CC} ≤ 3.6V Only)
- Current Limiting and Thermal Shutdown for Driver Overload Protection (V_{CC} ≤ 3.6V Only)
- Tri-statable Tx Outputs
- 5V Tolerant Logic Inputs When V_{CC} ≤ 5V
- Pb-Free (RoHS Compliant)

Applications

- Clock Distribution
- High Node Count Systems
- Space Constrained Systems
- Security Camera Networks
- Building Environmental Control/Lighting Systems
- Industrial/Process Control Networks

TABLE 1. SUMMARY OF FEATURES

PART NUMBER	FUNCTION	DATA RATE (Mbps)	SLEW-RATE LIMITED?	HOT PLUG?	V _L PIN?	TX ENABLE? (Note 10)	MAXIMUM QUIESCENT I _{CC} (µA)	LOW POWER SHUTDOWN?	PIN COUNT
ISL3293E	1 Tx	0.25	YES	YES	NO	YES	150	YES	6 Ld SOT
ISL3294E	1 Tx	0.5	YES	YES	NO	YES	150	YES	6 Ld SOT
ISL3295E	1 Tx	20	NO	YES	NO	YES	150	YES	6 Ld SOT
ISL3296E	1 Tx	0.25	YES	YES	YES	YES	150	YES	8 Ld TDFN
ISL3297E	1 Tx	0.5	YES	YES	YES	YES	150	YES	8 Ld TDFN
ISL3298E	1 Tx	20	NO	YES	YES	YES	150	YES	8 Ld TDFN

Pinouts

ISL3293E, ISL3294E, ISL3295E
(6 LD SOT-23)
TOP VIEW

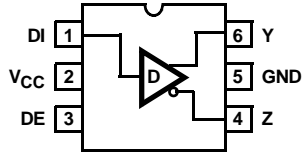

ISL3296E, ISL3297E, ISL3298E
(8 LD TDFN)
TOP VIEW

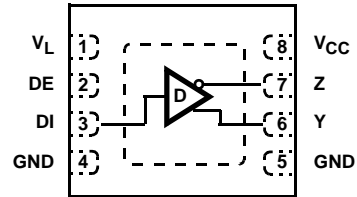

NOTE: BOTH GND PINS MUST BE CONNECTED

Ordering Information

PART NUMBER (Notes 1, 2)	PART MARKING (Note 3)	TEMP. RANGE (°C)	PACKAGE (Tape and Reel) (Pb-Free)	PKG. DWG. #
ISL3293EFHZ-T	293F	-40 to +125	6 Ld SOT-23	P6.064
ISL3293EIHZ-T	293I	-40 to +85	6 Ld SOT-23	P6.064
ISL3294EFHZ-T	294F	-40 to +125	6 Ld SOT-23	P6.064
ISL3294EIHZ-T	294I	-40 to +85	6 Ld SOT-23	P6.064
ISL3295EFHZ-T	295F	-40 to +125	6 Ld SOT-23	P6.064
ISL3295EIHZ-T	295I	-40 to +85	6 Ld SOT-23	P6.064
ISL3296EFRTZ-T	96F	-40 to +125	8 Ld TDFN	L8.2x3A
ISL3296EIRTZ-T	96I	-40 to +85	8 Ld TDFN	L8.2x3A
ISL3297EFRTZ-T	97F	-40 to +125	8 Ld TDFN	L8.2x3A
ISL3297EIRTZ-T	97I	-40 to +85	8 Ld TDFN	L8.2x3A
ISL3298EFRTZ-T	98F	-40 to +125	8 Ld TDFN	L8.2x3A
ISL3298EIRTZ-T	98I	-40 to +85	8 Ld TDFN	L8.2x3A

NOTES:

1. These Intersil Pb-free plastic packaged products employ special Pb-free material sets; molding compounds/die attach materials and 100% matte tin plate PLUS ANNEAL - e3 termination finish, which is RoHS compliant and compatible with both SnPb and Pb-free soldering operations. Intersil Pb-free products are MSL classified at Pb-free peak reflow temperatures that meet or exceed the Pb-free requirements of IPC/JEDEC J STD-020.
2. Please refer to TB347 for details on reel specifications.
3. SOT-23 "PART MARKING" is branded on the bottom side.

Truth Tables

TRANSMITTING			
INPUTS		OUTPUTS	
DE (Note 10)	DI	Z	Y
1	1	0	1
1	0	1	0
0	X	High-Z *	High-Z *

NOTE: *Shutdown Mode

Pin Descriptions

PIN	FUNCTION
DE	Driver output enable. The driver outputs, Y and Z, are enabled by bringing DE high, and are high impedance when DE is low. If the driver enable function isn't needed, connect DE to V_{CC} (or V_L) through a 1k Ω to 3k Ω resistor.
DI	Driver input. A low on DI forces output Y low and output Z high. Similarly, a high on DI forces output Y high and output Z low.
GND	Ground connection. This is also the potential of the TDFN thermal pad.
Y	± 15 kV HBM, ± 7 kV IEC61000 (contact method) ESD Protected RS-485/422 level, noninverting transmitter output.
Z	± 15 kV HBM, ± 7 kV IEC61000 (contact method) ESD Protected RS-485/422 level, inverting transmitter output.
V_{CC}	System power supply input (3.0V to 5.5V). On devices with a V_L pin, power-up V_{CC} first.
V_L	Logic-Level supply which sets the V_{IL}/V_{IH} levels for the DI and DE pins (ISL3296E, ISL3297E, ISL3298E only). Power-up this supply after V_{CC} , and keep $V_L \leq V_{CC}$.

Typical Operating Circuits

NETWORK WITH ENABLES

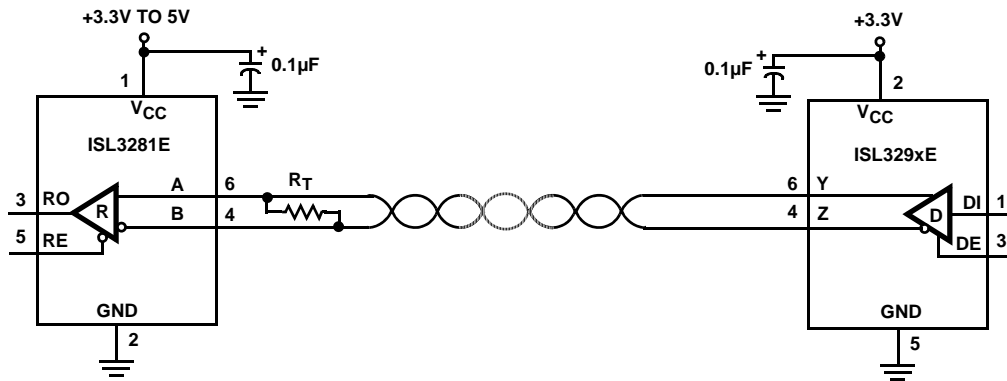

NETWORK WITHOUT ENABLE

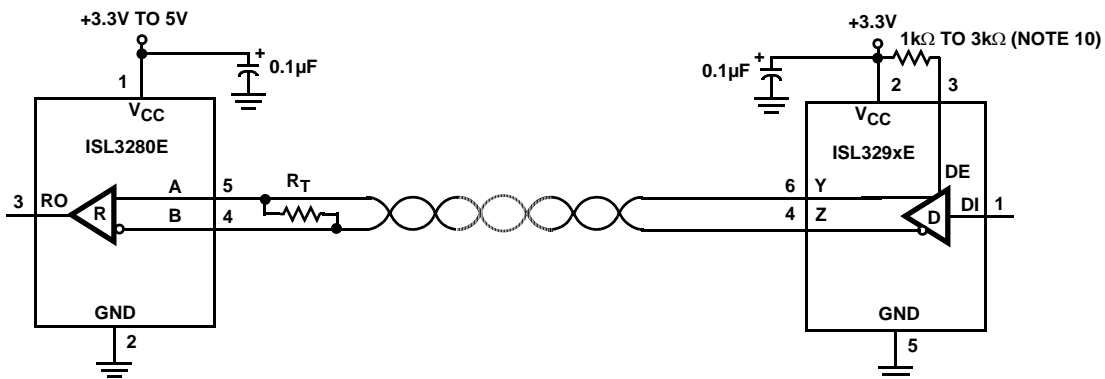

NETWORK WITH V_L PIN FOR INTERFACING TO LOWER VOLTAGE LOGIC DEVICES

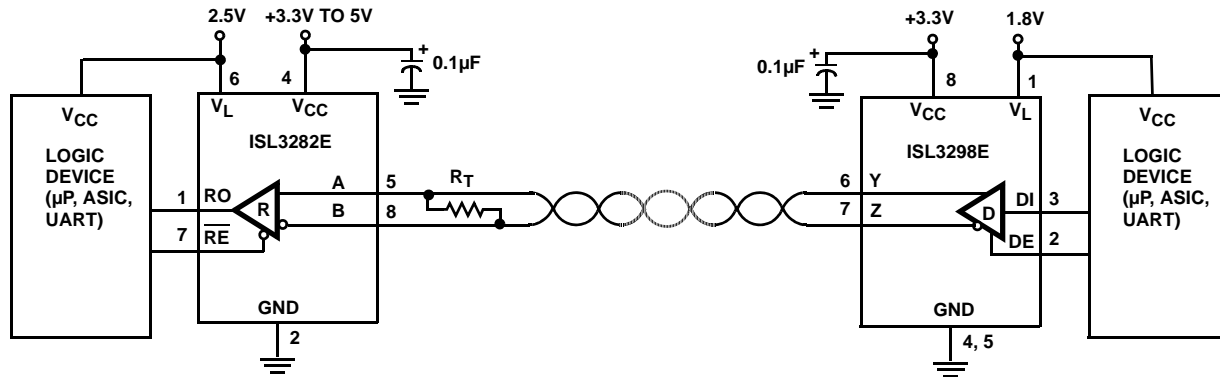

ISL3293E, ISL3294E, ISL3295E, ISL3296E, ISL3297E, ISL3298E

Absolute Maximum Ratings

V _{CC} to GND	-0.3V to 7V
V _L to GND (ISL3296E thru ISL3298E Only)	-0.3V to (V _{CC} +0.3V)
Input Voltages	
DI, DE	-0.3V to 7V
Output Voltages	
Y, Z (V _{CC} ≤ 3.6V)	-8V to +13V
Y, Z (V _{CC} > 3.6V)	-0.5V to V _{CC} +0.5V
Short Circuit Duration	
Y, Z (V _{CC} ≤ 3.6V)	Continuous
Y, Z (V _{CC} > 3.6V, Note 12)	1s at <300mA
ESD Rating	See Specification Table

Thermal Information

Thermal Resistance (Typical)	θ _{JA} (°C/W)	θ _{JC} (°C/W)
6 Ld SOT-23 Package (Note 4)	177	N/A
8 Ld TDFN Package (Notes 5, 6)	65	8
Maximum Junction Temperature (Plastic Package)	+150°C	
Maximum Storage Temperature Range	-65°C to +150°C	
Pb-free reflow profile	see link below	
	http://www.intersil.com/pbfree/Pb-FreeReflow.asp	

Operating Conditions

Temperature Range	
F Suffix (V _{CC} ≤ 3.6V Only)	-40°C to +125°C
I Suffix	-40°C to +85°C

CAUTION: Do not operate at or near the maximum ratings listed for extended periods of time. Exposure to such conditions may adversely impact product reliability and result in failures not covered by warranty.

NOTES:

- θ_{JA} is measured with the component mounted on a high effective thermal conductivity test board in free air. See Tech Brief TB379 for details.
- θ_{JA} is measured in free air with the component mounted on a high effective thermal conductivity test board with "direct attach" features. See Tech Brief TB379.
- For θ_{JC}, the "case temp" location is the center of the exposed metal pad on the package underside.

Electrical Specifications Test Conditions: V_{CC} = 3.0V to 5.5V; V_L = V_{CC} (ISL3296E, ISL3297E, ISL3298E only); Typical values are at T_A = +25°C; Unless Otherwise Specified. (Note 7)

PARAMETER	SYMBOL	TEST CONDITIONS	TEMP (°C)	MIN (Note 11)	TYP (Note 13)	MAX (Note 11)	UNITS	
DC CHARACTERISTICS								
Driver Differential V _{OUT}	V _{OD}	R _L = 100Ω (RS-422) (Figure 1A)	V _{CC} ≥ 3.15V	Full	2	2.3	-	V
			V _{CC} ≥ 4.5V	Full	3	3.8	-	V
	R _L = 54Ω (RS-485) (Figure 1A)	V _{CC} ≥ 3.0V	Full	1.5	2	V _{CC}	V	
		V _{CC} ≥ 4.5V	Full	2.5	3.4	V _{CC}	V	
	No Load	Full	-	-	V _{CC}			
		R _L = 60Ω, -7V ≤ V _{CM} ≤ 12V (Figure 1B)	Full	1.5	2, 3.4	-	V	
Change in Magnitude of Driver Differential V _{OUT} for Complementary Output States	ΔV _{OD}	R _L = 54Ω or 100Ω (Figure 1A)	Full	-	0.01	0.2	V	
Driver Common-Mode V _{OUT}	V _{OC}	R _L = 54Ω or 100Ω (Figure 1A)	V _{CC} ≤ 3.6V	Full	-	2	3	V
			V _{CC} ≤ 5.5V	Full	-	-	3.2	V
Change in Magnitude of Driver Common-Mode V _{OUT} for Complementary Output States	ΔV _{OC}	R _L = 54Ω or 100Ω (Figure 1A)	Full	-	0.01	0.2	V	
Input High Voltage (DI, DE)	V _{IH1}	V _L = V _{CC} if ISL3296E, ISL3297E, ISL3298E	V _{CC} ≤ 3.6V	Full	2.2	-	-	V
	V _{IH2}		V _{CC} ≤ 5.5V	Full	3	-	-	V
	V _{IH3}	2.7V ≤ V _L < 3.0V (ISL3296E, ISL3297E, ISL3298E only)	Full	2	-	-	V	
	V _{IH4}	2.3V ≤ V _L < 2.7V (ISL3296E, ISL3297E, ISL3298E only)	Full	1.65	-	-	V	
	V _{IH5}	1.6V ≤ V _L < 2.3V (ISL3296E, ISL3297E, ISL3298E only)	Full	0.7*V _L	-	-	V	
	V _{IH6}	1.35V ≤ V _L < 1.6V (ISL3296E, ISL3297E, ISL3298E only)	25	-	0.5*V _L	-	V	

ISL3293E, ISL3294E, ISL3295E, ISL3296E, ISL3297E, ISL3298E

Electrical Specifications Test Conditions: $V_{CC} = 3.0V$ to $5.5V$; $V_L = V_{CC}$ (ISL3296E, ISL3297E, ISL3298E only); Typicals are at $T_A = +25^\circ C$; Unless Otherwise Specified. (Note 7) **(Continued)**

PARAMETER	SYMBOL	TEST CONDITIONS	TEMP (°C)	MIN (Note 11)	TYP (Note 13)	MAX (Note 11)	UNITS	
Input Low Voltage (DI, DE)	V_{IL1}	$V_L = V_{CC}$ if ISL3296E, ISL3297E, ISL3298E	Full	-	-	0.8	V	
	V_{IL2}	$V_L \geq 2.7V$ (ISL3296E, ISL3297E, ISL3298E only)	Full	-	-	0.8	V	
	V_{IL3}	$2.3V \leq V_L < 2.7V$ (ISL3296E, ISL3297E, ISL3298E only)	Full	-	-	0.65	V	
	V_{IL4}	$1.6V \leq V_L < 2.3V$ (ISL3296E, ISL3297E, ISL3298E only)	Full	-	-	$0.22 \cdot V_L$	V	
	V_{IL5}	$1.35V \leq V_L < 1.6V$ (ISL3296E, ISL3297E, ISL3298E only)	25	-	$0.3 \cdot V_L$	-	V	
Logic Input Current	I_{IN}	DI = DE = 0V or V_{CC} (Note 10)	Full	-2	-	2	μA	
Output Leakage Current (Y, Z, Note 10)	I_{OZ}	DE = 0V, $V_{CC} = 0V, 3.6V,$ or 5.5V	$V_{IN} = 12V$	Full	-	0.1	40	μA
			$V_{IN} = -7V$	Full	-40	-10	-	μA
Driver Short-Circuit Current, $V_O =$ High or Low (Note 8)	I_{OSD1}	DE = V_{CC} , $-7V \leq V_O \leq 12V$, $V_{CC} \leq 3.6V$	Full	-	-	± 250	mA	
		DE = V_{CC} , $0V \leq V_O \leq V_{CC}$, $V_{CC} > 3.6V$ (Note 12)	Full	-	-	± 450	mA	
Thermal Shutdown Threshold	T_{SD}		Full	-	160	-	$^\circ C$	
SUPPLY CURRENT								
No-Load Supply Current	I_{CC}	DI = 0V or V_{CC}	DE = V_{CC}	Full	-	120	150	μA
Shutdown Supply Current	I_{SHDN}	DE = 0V, DI = 0V or V_{CC}		Full	-	0.01	1	μA
ESD PERFORMANCE								
RS-485 Pins (Y, Z)		Human Body Model, From Bus Pins to GND	25	-	± 16.5	-	kV	
		IEC61000 Contact, From Bus Pins to GND	25	-	± 7	-	kV	
All Pins		HBM, per MIL-STD-883 Method 3015	25	-	± 8	-	kV	
		Machine Model	25	-	± 400	-	V	
DRIVER SWITCHING CHARACTERISTICS (ISL3293E, ISL3296E, 250kbps)								
Maximum Data Rate	f_{MAX}	$V_{OD} = \pm 1.5V$, $C_D = 820pF$ (Figure 4)	Full	250	-	-	kbps	
Driver Single Ended Output Delay	t_{SD}	$R_{DIFF} = 54\Omega$, $C_D = 50pF$ (Figure 2)	Full	400	1350	1700	ns	
Part-to-Part Output Delay Skew	t_{SKPP}	$R_{DIFF} = 54\Omega$, $C_D = 50pF$ (Figure 2, Note 9)	Full	-	-	900	ns	
Driver Single Ended Output Skew	t_{SSK}	$R_{DIFF} = 54\Omega$, $C_D = 50pF$ (Figure 2)	Full	-	600	750	ns	
Driver Differential Output Delay	t_{DD}	$R_{DIFF} = 54\Omega$, $C_D = 50pF$ (Figure 2)	Full	400	1100	1500	ns	
Driver Differential Output Skew	t_{DSK}	$R_{DIFF} = 54\Omega$, $C_D = 50pF$ (Figure 2)	Full	-	4, 1	30	ns	
Driver Differential Rise or Fall Time	t_R, t_F	$R_{DIFF} = 54\Omega$, $C_D = 50pF$ (Figure 2)	$V_{CC} \leq 3.6V$	Full	400	960	1500	ns
			$V_{CC} = 5V$	25	-	1300	-	ns
Driver Enable to Output High	t_{ZH}	$R_L = 500\Omega$, $C_L = 50pF$, SW = GND (Figure 3)	Full	-	100, 60	250	ns	
Driver Enable to Output Low	t_{ZL}	$R_L = 500\Omega$, $C_L = 50pF$, SW = V_{CC} (Figure 3)	Full	-	60, 35	250	ns	
Driver Disable from Output High	t_{HZ}	$R_L = 500\Omega$, $C_L = 50pF$, SW = GND (Figure 3)	Full	-	30, 22	60	ns	
Driver Disable from Output Low	t_{LZ}	$R_L = 500\Omega$, $C_L = 50pF$, SW = V_{CC} (Figure 3)	Full	-	25, 20	60	ns	

ISL3293E, ISL3294E, ISL3295E, ISL3296E, ISL3297E, ISL3298E

Electrical Specifications Test Conditions: $V_{CC} = 3.0V$ to $5.5V$; $V_L = V_{CC}$ (ISL3296E, ISL3297E, ISL3298E only); Typicals are at $T_A = +25^\circ C$; Unless Otherwise Specified. (Note 7) **(Continued)**

PARAMETER	SYMBOL	TEST CONDITIONS	TEMP (°C)	MIN (Note 11)	TYP (Note 13)	MAX (Note 11)	UNITS	
DRIVER SWITCHING CHARACTERISTICS (ISL3294E, ISL3297E, 500kbps)								
Maximum Data Rate	f_{MAX}	$V_{OD} = \pm 1.5V$, $C_D = 820pF$ (Figure 4)	Full	500	-	-	kbps	
Driver Single Ended Output Delay	t_{SD}	$R_{DIFF} = 54\Omega$, $C_D = 50pF$ (Figure 2)	Full	200	340	500	ns	
Part-to-Part Output Delay Skew	t_{SKPP}	$R_{DIFF} = 54\Omega$, $C_D = 50pF$ (Figure 2, Note 9)	Full	-	-	300	ns	
Driver Single Ended Output Skew	t_{SSK}	$R_{DIFF} = 54\Omega$, $C_D = 50pF$ (Figure 2)	Full	-	30, 80	150	ns	
Driver Differential Output Delay	t_{DD}	$R_{DIFF} = 54\Omega$, $C_D = 50pF$ (Figure 2)	Full	200	345	500	ns	
Driver Differential Output Skew	t_{DSK}	$R_{DIFF} = 54\Omega$, $C_D = 50pF$ (Figure 2)	Full	-	2	30	ns	
Driver Differential Rise or Fall Time	t_R, t_F	$R_{DIFF} = 54\Omega$, $C_D = 50pF$ (Figure 2)	Full	200	350	800	ns	
Driver Enable to Output High	t_{ZH}	$R_L = 500\Omega$, $C_L = 50pF$, $SW = GND$ (Figure 3)	Full	-	100, 60	250	ns	
Driver Enable to Output Low	t_{ZL}	$R_L = 500\Omega$, $C_L = 50pF$, $SW = V_{CC}$ (Figure 3)	Full	-	60, 35	250	ns	
Driver Disable from Output High	t_{HZ}	$R_L = 500\Omega$, $C_L = 50pF$, $SW = GND$ (Figure 3)	Full	-	30, 22	60	ns	
Driver Disable from Output Low	t_{LZ}	$R_L = 500\Omega$, $C_L = 50pF$, $SW = V_{CC}$ (Figure 3)	Full	-	25, 20	60	ns	
DRIVER SWITCHING CHARACTERISTICS (ISL3295E, ISL3298E, 20Mbps)								
Maximum Data Rate	f_{MAX}	$V_{OD} = \pm 1.5V$, $C_D = 360pF$ (Figure 4)	Full	20	-	-	Mbps	
Driver Single Ended Output Delay	t_{SD}	$R_{DIFF} = 54\Omega$, $C_D = 50pF$ (Figure 2)	$V_L = V_{CC}$	Full	15	29, 23	42	ns
			$V_L \geq 1.8V$	25	-	32	-	ns
			$V_L = 1.5V$	25	-	36	-	ns
			$V_L = 1.35V$	25	-	40	-	ns
Part-to-Part Output Delay Skew	t_{SKPP}	$R_{DIFF} = 54\Omega$, $C_D = 50pF$ (Figure 2, Note 9)	Full	-	-	25	ns	
Driver Single Ended Output Skew	t_{SSK}	$R_{DIFF} = 54\Omega$, $C_D = 50pF$ (Figure 2)	$V_L = V_{CC}$	Full	-	3	7	ns
			$V_L \geq 1.8V$	25	-	3	-	ns
			$V_L = 1.5V$	25	-	4	-	ns
			$V_L = 1.35V$	25	-	5	-	ns
Driver Differential Output Delay	t_{DD}	$R_{DIFF} = 54\Omega$, $C_D = 50pF$ (Figure 2)	$V_L = V_{CC}$	Full	-	29, 22	42	ns
			$V_L \geq 1.8V$	25	-	32	-	ns
			$V_L = 1.5V$	25	-	36	-	ns
			$V_L = 1.35V$	25	-	42	-	ns
Driver Differential Output Skew	t_{DSK}	$R_{DIFF} = 54\Omega$, $C_D = 50pF$ (Figure 2)	$V_L = V_{CC} \leq 3.6V$	Full	-	0.5	3	ns
			$V_L = V_{CC} = 5V$	25	-	2	-	ns
			$V_L \geq 1.8V$	25	-	0.5, 1	-	ns
			$V_L \geq 1.5V$	25	-	1, 2	-	ns
			$V_L = 1.35V$	25	-	2, 4	-	ns
Driver Differential Rise or Fall Time	t_R, t_F	$R_{DIFF} = 54\Omega$, $C_D = 50pF$ (Figure 2)	$V_L = V_{CC}$	Full	-	9	15	ns
			$V_L \geq 1.35V$	25	-	9	-	ns
Driver Enable to Output High	t_{ZH}	$R_L = 500\Omega$, $C_L = 50pF$, $SW = GND$ (Figure 3)	Full	-	100, 60	250	ns	
Driver Enable to Output Low	t_{ZL}	$R_L = 500\Omega$, $C_L = 50pF$, $SW = V_{CC}$ (Figure 3)	Full	-	60, 35	250	ns	

Electrical Specifications Test Conditions: $V_{CC} = 3.0V$ to $5.5V$; $V_L = V_{CC}$ (ISL3296E, ISL3297E, ISL3298E only); Typicals are at $T_A = +25^\circ C$; Unless Otherwise Specified. (Note 7) **(Continued)**

PARAMETER	SYMBOL	TEST CONDITIONS	TEMP (°C)	MIN (Note 11)	TYP (Note 13)	MAX (Note 11)	UNITS
Driver Disable from Output High	t_{HZ}	$R_L = 500\Omega$, $C_L = 50pF$, SW = GND (Figure 3)	Full	-	30, 22	60	ns
Driver Disable from Output Low	t_{LZ}	$R_L = 500\Omega$, $C_L = 50pF$, SW = V_{CC} (Figure 3)	Full	-	25, 20	60	ns

NOTES:

- All currents into device pins are positive; all currents out of device pins are negative. All voltages are referenced to device ground unless otherwise specified.
- Applies to peak current. See "Typical Performance Curves" on page 12 for more information.
- t_{SKPP} is the magnitude of the difference in propagation delays of the specified terminals of two units tested with identical test conditions (V_{CC} , temperature, etc.).
- If the driver enable function isn't needed, connect DE to V_{CC} (or V_L) through a $1k\Omega$ to $3k\Omega$ resistor.
- Parts are 100% tested at $+25^\circ C$. Over-temperature limits established by characterization and are not production tested.
- Due to the high short circuit current at $V_{CC} > 3.6V$, the outputs must not be shorted outside the range of GND to V_{CC} or damage may occur. To prevent excessive power dissipation that may damage the output, the short circuit current should be limited to $\leq 300mA$ during testing. It is best to use an external resistor for this purpose, since the current limiting on the V_O supply may respond too slowly to protect the output.
- Typicals are measured at $V_{CC} = 3.3V$ for parameters specified with $3V \leq V_{CC} \leq 3.6V$, and are measured at $V_{CC} = 5V$ for parameters specified with $4.5V \leq V_{CC} \leq 5.5V$. If V_{CC} isn't specified, then a single "TYP" entry applies to both $V_{CC} = 3.3V$ and $5V$, and two entries separated by a comma refer to $V_{CC} = 3.3V$ and $5V$, respectively.

Test Circuits and Waveforms

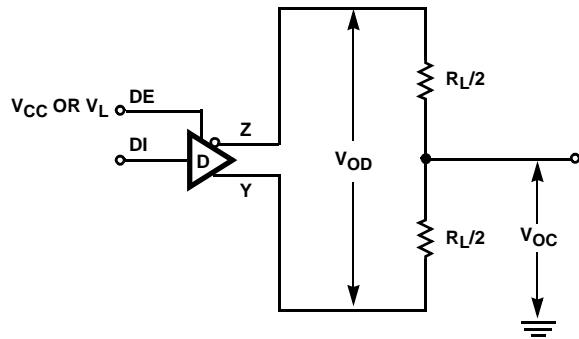

FIGURE 1A. V_{OD} AND V_{OC}

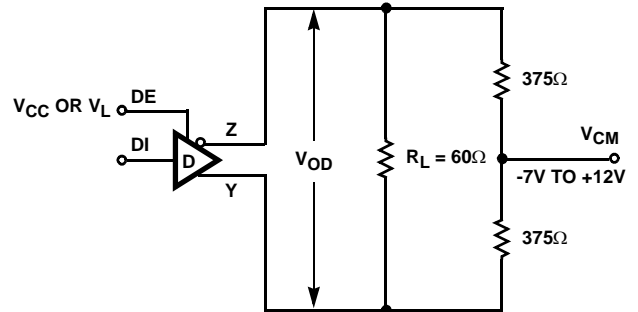

FIGURE 1B. V_{OD} WITH COMMON MODE LOAD

FIGURE 1. DC DRIVER TEST CIRCUITS

Test Circuits and Waveforms (Continued)

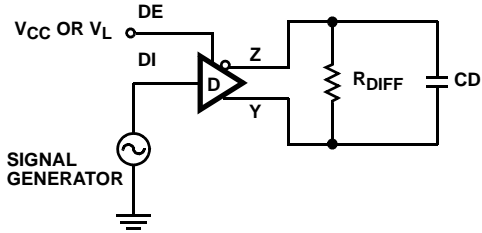
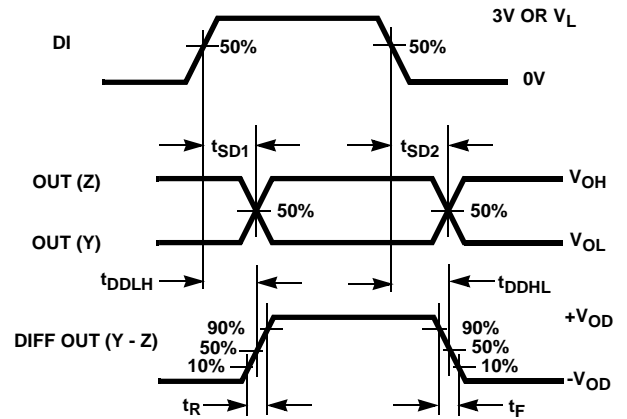

FIGURE 2A. TEST CIRCUIT



$$t_{SSK} = |t_{SD1}(Y) - t_{SD2}(Y)| \text{ OR } |t_{SD1}(Z) - t_{SD2}(Z)| \quad t_{DSK} = |t_{DDLH} - t_{DDHL}|$$

FIGURE 2B. MEASUREMENT POINTS

FIGURE 2. DRIVER PROPAGATION DELAY AND DIFFERENTIAL TRANSITION TIMES

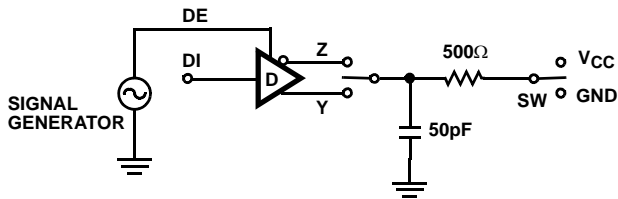

PARAMETER	OUTPUT	DI	SW
t_{HZ}	Y/Z	1/0	GND
t_{LZ}	Y/Z	0/1	V_{CC}
t_{ZH}	Y/Z	1/0	GND
t_{ZL}	Y/Z	0/1	V_{CC}

FIGURE 3A. TEST CIRCUIT

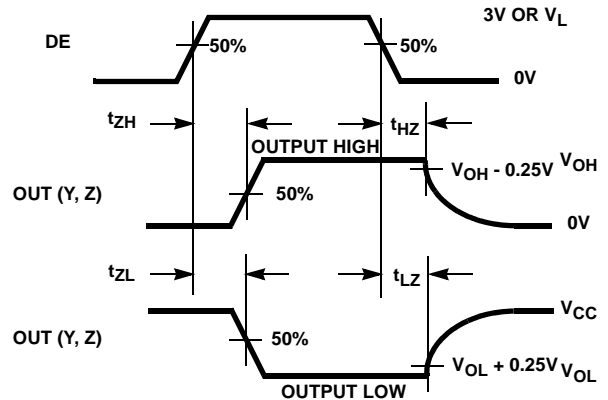

FIGURE 3B. MEASUREMENT POINTS

FIGURE 3. DRIVER ENABLE AND DISABLE TIMES

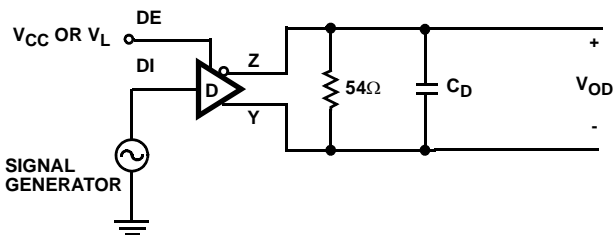

FIGURE 4A. TEST CIRCUIT

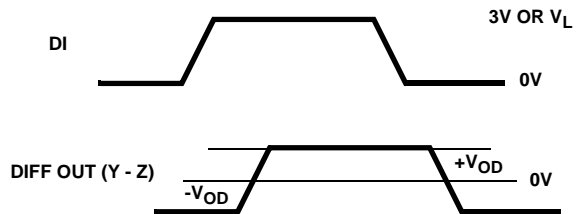

FIGURE 4B. MEASUREMENT POINTS

FIGURE 4. DRIVER DATA RATE

Application Information

RS-485 and RS-422 are differential (balanced) data transmission standards for use in long haul or noisy environments. RS-422 is a subset of RS-485, so RS-485 transmitters and receivers are also RS-422 compliant. RS-422 is a point-to-multipoint (multidrop) standard, which allows only one driver and up to 10 (assuming one unit load devices) receivers on each bus. RS-485 is a true multipoint standard, which allows up to 32 one unit load devices (any combination of drivers and receivers) on each bus. To allow for multipoint operation, the RS-485 specification requires that drivers must handle bus contention without sustaining any damage.

Another important advantage of RS-485 is the extended common mode range (CMR), which specifies that the driver outputs and receiver inputs withstand signals that range from +12V to -7V. RS-422 and RS-485 are intended for runs as long as 4000', so the wide CMR is necessary to handle ground potential differences, as well as voltages induced in the cable by external fields.

Driver Features

These RS-485/RS-422 drivers are differential output devices that delivers at least 1.5V across a 54Ω load (RS-485), and at least 2V across a 100Ω load (RS-422). The drivers feature low propagation delay skew to maximize bit width, and to minimize EMI.

All drivers are tri-statable via the active high DE input. If the Tx enable function isn't needed, tie DE to V_{CC} (or V_L) through a 1kΩ to 3kΩ resistor.

The 250kbps and 500kbps driver outputs are slew rate limited to minimize EMI, and to reduce reflections in unterminated or improperly terminated networks. Outputs of the ISL3295E and ISL3298E drivers are not limited, so faster output transition times allow data rates of at least 20Mbps.

Wide Supply Range

The ISL3293E through ISL3298E are optimized for 3.3V operation, but can be operated with supply voltages as high as 5.5V. These devices meet the RS-422 and RS-485 specifications for supply voltages less than 4V, and are RS-422 and RS-485 compatible for supplies greater than 4V. Operation at +125°C requires $V_{CC} \leq 3.6V$, while 5V operation requires adding output current limiting resistors (as described in the "Driver Overload Protection" on page 11) if output short circuits (e.g., from bus contention) are a possibility.

5.5V Tolerant Logic Pins

Logic input pins (DI, DE) contain no ESD nor parasitic diodes to V_{CC} (nor to V_L), so they withstand input voltages exceeding 5.5V regardless of the V_{CC} and V_L voltages.

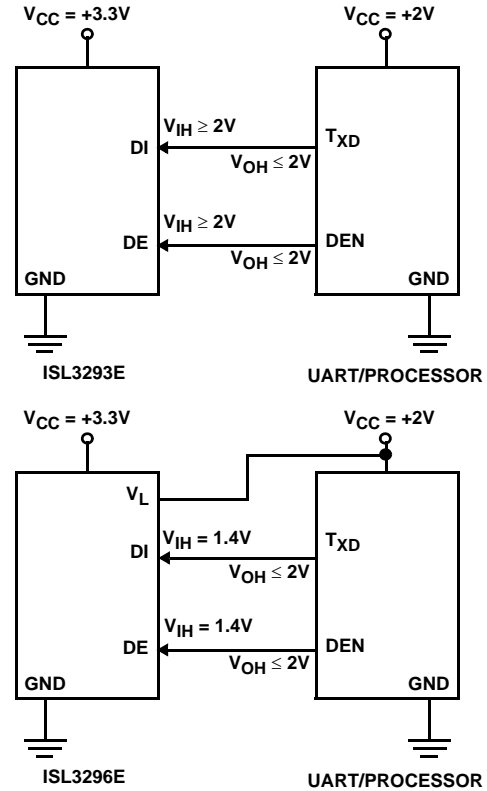

FIGURE 5. USING V_L PIN TO ADJUST LOGIC LEVELS

Logic Supply (V_L Pin, ISL3296E through ISL3298E)

Note: Power-up V_{CC} before powering up the V_L supply.

The ISL3296E through ISL3298E include a V_L pin that powers the logic inputs (DI and DE). These pins interface with "logic" devices such as UARTs, ASICs, and μ controllers, and today most of these devices use power supplies significantly lower than 3.3V. Thus, the logic device's low V_{OH} might not exceed the V_{IH} of a 3.3V or 5V powered DI or DE input. Connecting the V_L pin to the power supply of the logic device (as shown in Figure 5) reduces the DI and DE input switching points to values compatible with the logic device's output levels. Tailoring the logic pin input switching points and output levels to the supply voltage of the UART, ASIC, or μ controller eliminates the need for a level shifter/translator between the two ICs.

V_L can be anywhere from V_{CC} down to 1.35V, but the input switching points may not provide enough noise margin, and 20Mbps data rates may not be achievable, when $V_L < 1.5V$. Table 2 indicates typical V_{IH} and V_{IL} values for various V_L settings so the user can ascertain whether or not a particular V_L voltage meets his needs.

TABLE 2. V_{IH} AND V_{IL} vs V_L FOR $V_{CC} = 3.3V$ OR $5V$

V_L (V)	V_{IH} (V)	V_{IL} (V)
1.35	0.7	0.4
1.5	0.8	0.5
1.8	0.9	0.7
2.3	1.1	1.0
2.7	1.3	1.1
3.3	1.5	1.4
5.0 (i.e., V_{CC})	2.7	2.3

The V_L supply current (I_L) is typically much less than $20\mu A$, as shown in Figure 9, when DE and DI are above/below V_{IH}/V_{IL} .

Hot Plug Function

When a piece of equipment powers-up, there is a period of time where the processor or ASIC driving the RS-485 control line (DE) is unable to ensure that the RS-485 Tx outputs are kept disabled. If the equipment is connected to the bus, a driver activating prematurely during power up may crash the bus. To avoid this scenario, the ISL329xE family incorporates a “Hot Plug” function. During power-up, circuitry monitoring V_{CC} ensures that the Tx outputs remain disabled for a period of time, regardless of the state of DE. This gives the processor/ASIC a chance to stabilize and drive the RS-485 control lines to the proper states.

ESD Protection

All pins on these devices include class 3 (8kV) Human Body Model (HBM) ESD protection structures, but the RS-485 pins (driver outputs) incorporate advanced structures allowing them to survive ESD events in excess of $\pm 16.5kV$ HBM and $\pm 7kV$ to the IEC61000 contact test method. The RS-485 pins are particularly vulnerable to ESD damage because they typically connect to an exposed port on the exterior of the finished product. Simply touching the port pins, or connecting a cable, can cause an ESD event that might destroy unprotected ICs. These new ESD structures protect the device whether or not it is powered up, and without degrading the RS-485 common mode range of $-7V$ to $+12V$. This built-in ESD protection eliminates the need for board level protection structures (e.g., transient suppression diodes), and the associated, undesirable capacitive load they present.

Data Rate, Cables, and Terminations

RS-485/RS-422 are intended for network lengths up to 4000', but the maximum system data rate decreases as the transmission length increases. Devices operating at 20Mbps are limited to lengths less than 100', while the 250kbps versions can operate at full data rates with lengths of several 1000'.

Twisted pair is the cable of choice for RS-485/RS-422 networks. Twisted pair cables tend to pick up noise and other electromagnetically induced voltages as common mode signals, which are effectively rejected by the differential receivers in these ICs.

Proper termination is imperative, when using the 20Mbps devices, to minimize reflections. Short networks using the 250kbps versions need not be terminated, but, terminations are recommended unless power dissipation is an overriding concern.

In point-to-point, or point-to-multipoint (single driver on bus) networks, the main cable should be terminated in its characteristic impedance (typically 120Ω) at the end farthest from the driver. In multi-receiver applications, stubs connecting receivers to the main cable should be kept as short as possible. Multipoint (multi-driver) systems require that the main cable be terminated in its characteristic impedance at both ends. Stubs connecting a transmitter or receiver to the main cable should be kept as short as possible.

Driver Overload Protection

As stated previously, the RS-485 specification requires that drivers survive worst case bus contentions undamaged. These drivers meet this requirement, for $V_{CC} \leq 3.6V$, via driver output short circuit current limits, and on-chip thermal shutdown circuitry.

The driver output stages incorporate short circuit current limiting circuitry which ensures that the output current never exceeds the RS-485 specification, for $V_{CC} \leq 3.6V$, even at the common mode voltage range extremes. Additionally, these devices utilize a foldback circuit which reduces the short circuit current, and thus the power dissipation, whenever the contending voltage exceeds either V_{CC} or GND.

In the event of a major short circuit condition, devices also include a thermal shutdown feature that disables the drivers whenever the die temperature becomes excessive. This eliminates the power dissipation, allowing the die to cool. The drivers automatically re-enable after the die temperature drops about $+20^\circ C$. If the contention persists, the thermal shutdown/re-enable cycle repeats until the fault is cleared.

At $V_{CC} > 3.6V$, the instantaneous short circuit current is high enough that output stage damage may occur during short circuit conditions to voltages outside of GND to V_{CC} , before the short circuit limiting and thermal shutdown activate. For $V_{CC} = 5V$ operation, if output short circuits are a possibility (e.g., due to bus contention), it is recommended that a 5Ω resistor be inserted in series with each output. This resistor limits the instantaneous current below levels that can cause damage. The driver V_{OD} at $V_{CC} = 5V$ is so large that this small added resistance has little impact.

High Temperature Operation

Due to power dissipation and instantaneous output short circuit current levels at $V_{CC} = 5V$, these transmitters may not be operated at $+125^{\circ}C$ with $V_{CC} > 3.6V$.

At $V_{CC} = 3.6V$, even the SOT-23 versions may be operated at $+125^{\circ}C$, while driving a 100', double terminated, CAT 5 cable at 20Mbps, without triggering the thermal SHDN circuit.

Low Power Shutdown Mode

These BiCMOS transmitters all use a fraction of the power required by their bipolar counterparts, but they also include a shutdown feature that reduces the already low quiescent I_{CC} to a $1\mu A$ trickle. These devices enter shutdown whenever the driver disables ($DE = GND$).

Typical Performance Curves $V_{CC} = V_L = 3.3V, T_A = +25^{\circ}C$; Unless Otherwise Specified

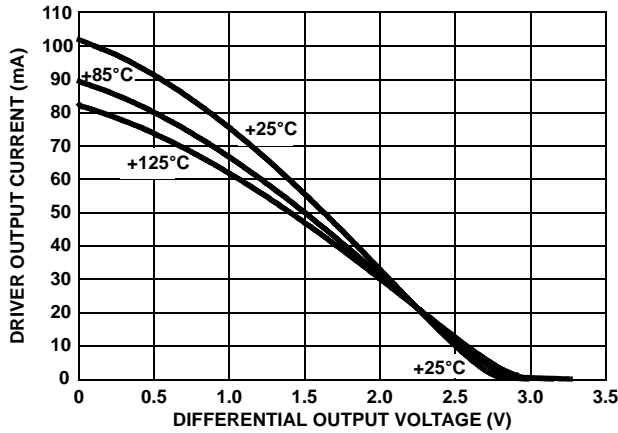

FIGURE 6. DRIVER OUTPUT CURRENT vs DIFFERENTIAL OUTPUT VOLTAGE

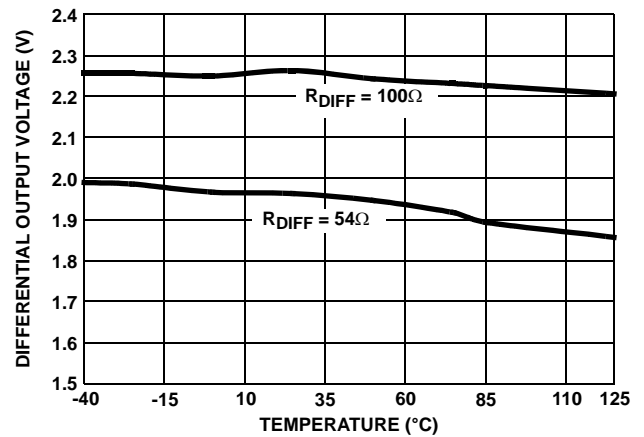

FIGURE 7. DRIVER DIFFERENTIAL OUTPUT VOLTAGE vs TEMPERATURE

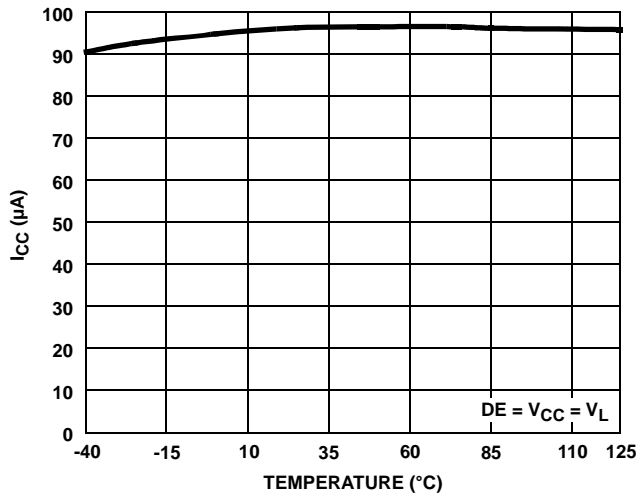

FIGURE 8. SUPPLY CURRENT vs TEMPERATURE

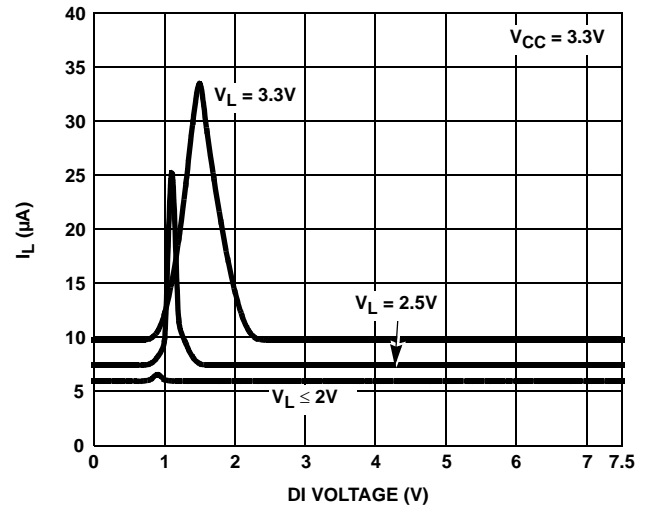

FIGURE 9. V_L SUPPLY CURRENT vs LOGIC PIN VOLTAGE

Typical Performance Curves $V_{CC} = V_L = 3.3V$, $T_A = +25^\circ C$; Unless Otherwise Specified (Continued)

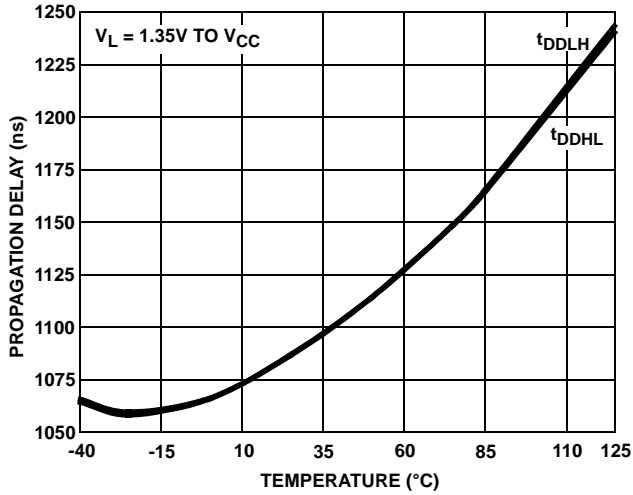

FIGURE 10. DRIVER DIFFERENTIAL PROPAGATION DELAY vs TEMPERATURE (ISL3293E, ISL3296E)

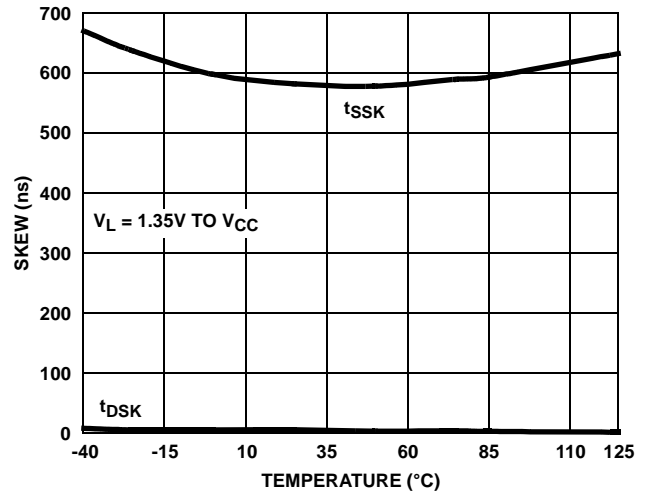

FIGURE 11. DRIVER SKEW vs TEMPERATURE (ISL3293E, ISL3296E)

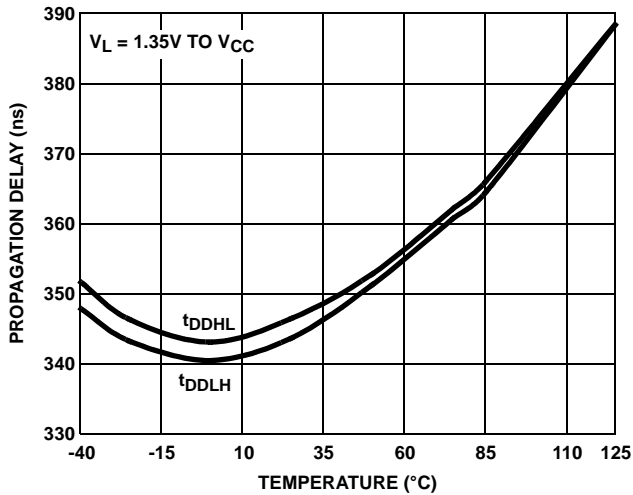

FIGURE 12. DRIVER DIFFERENTIAL PROPAGATION DELAY vs TEMPERATURE (ISL3294E, ISL3297E)

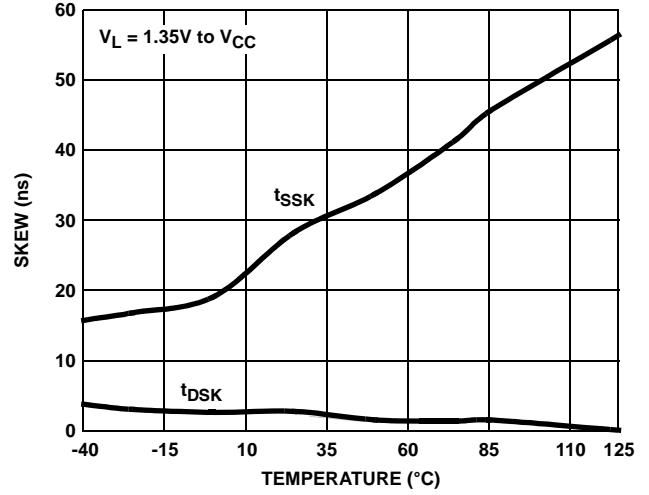

FIGURE 13. DRIVER SKEW vs TEMPERATURE (ISL3294E, ISL3297E)

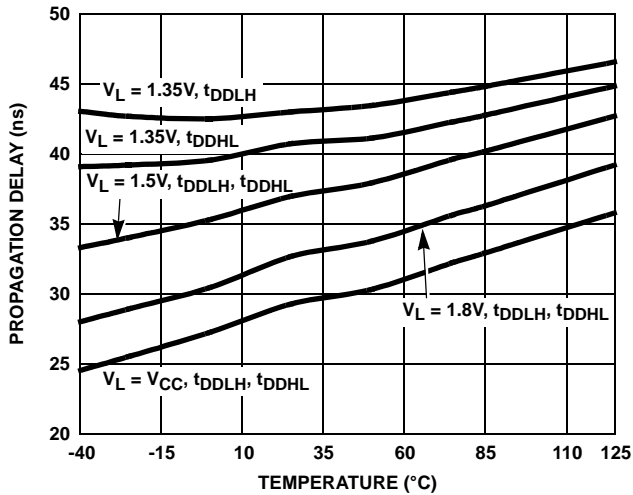

FIGURE 14. DRIVER DIFFERENTIAL PROPAGATION DELAY vs TEMPERATURE (ISL3295E, ISL3298E)

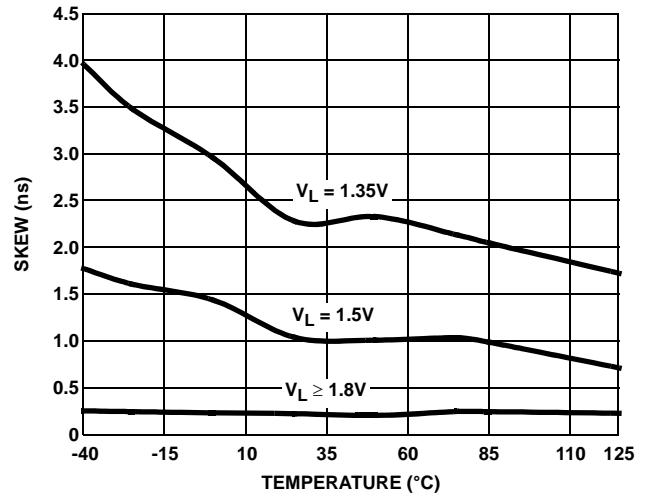

FIGURE 15. DRIVER DIFFERENTIAL SKEW vs TEMPERATURE (ISL3295E, ISL3298E)

Typical Performance Curves $V_{CC} = V_L = 3.3V$, $T_A = +25^\circ C$; Unless Otherwise Specified (Continued)

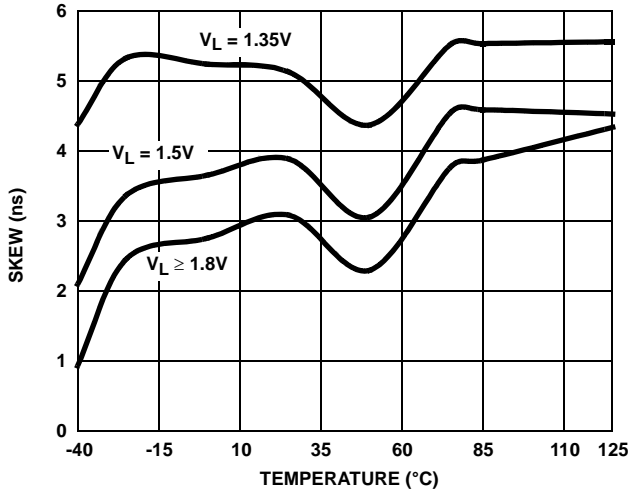

FIGURE 16. DRIVER SINGLE ENDED SKEW vs TEMPERATURE (ISL3295E, ISL3298E)

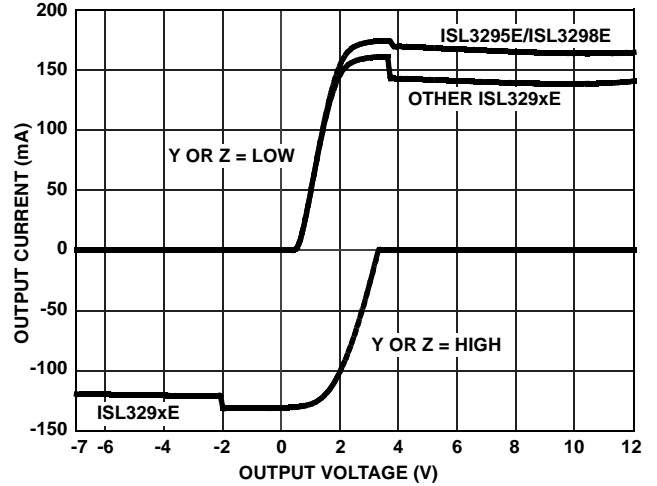

FIGURE 17. DRIVER OUTPUT CURRENT vs SHORT CIRCUIT VOLTAGE

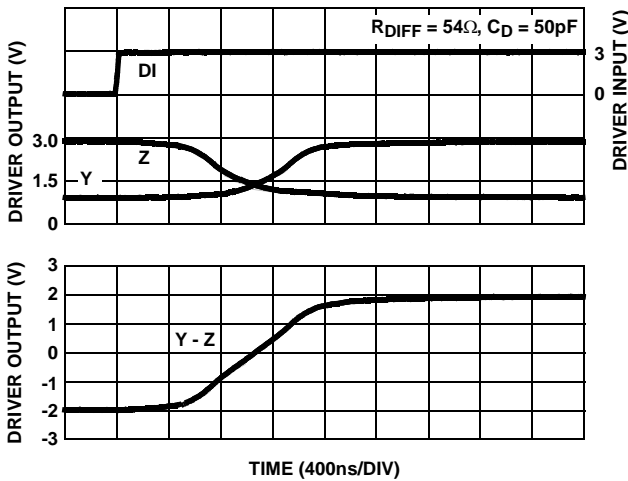

FIGURE 18. DRIVER WAVEFORMS, LOW TO HIGH (ISL3293E, ISL3296E)

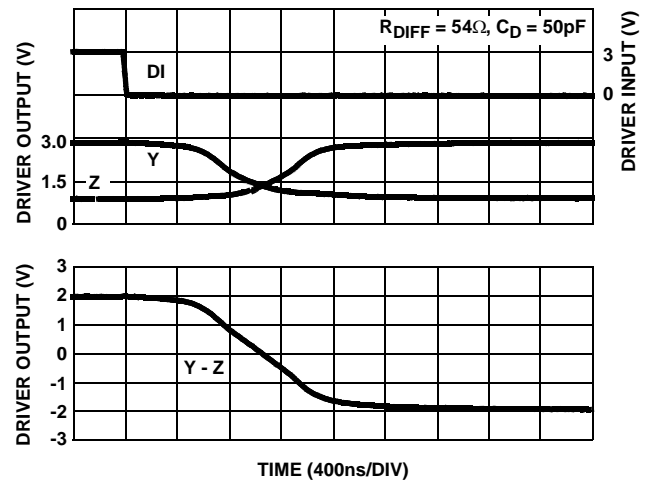

FIGURE 19. DRIVER WAVEFORMS, HIGH TO LOW (ISL3293E, ISL3296E)

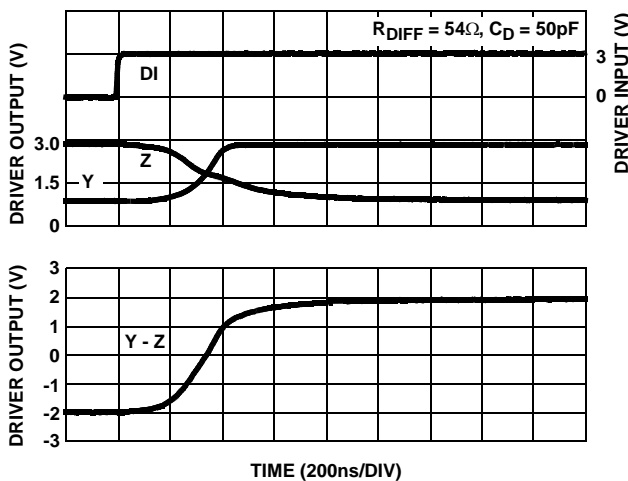

FIGURE 20. DRIVER WAVEFORMS, LOW TO HIGH (ISL3294E, ISL3297E)

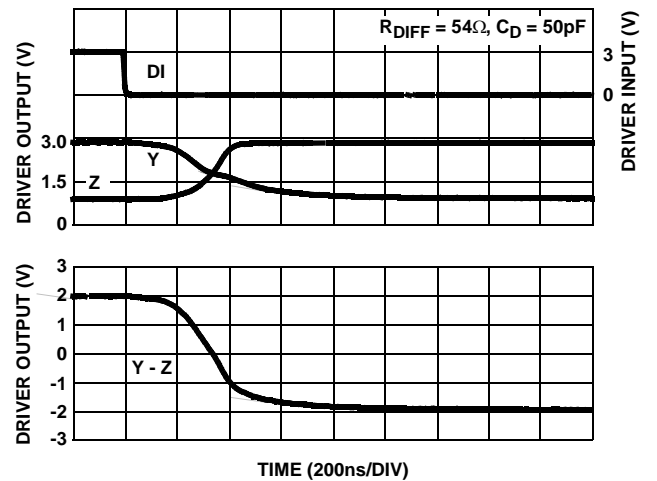

FIGURE 21. DRIVER WAVEFORMS, HIGH TO LOW (ISL3294E, ISL3297E)

Typical Performance Curves $V_{CC} = V_L = 3.3V$, $T_A = +25^\circ C$; Unless Otherwise Specified (Continued)

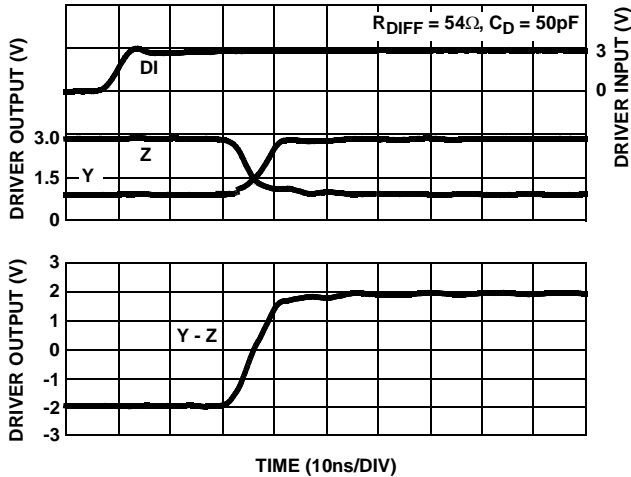

FIGURE 22. DRIVER WAVEFORMS, LOW TO HIGH (ISL3295E, ISL3298E)

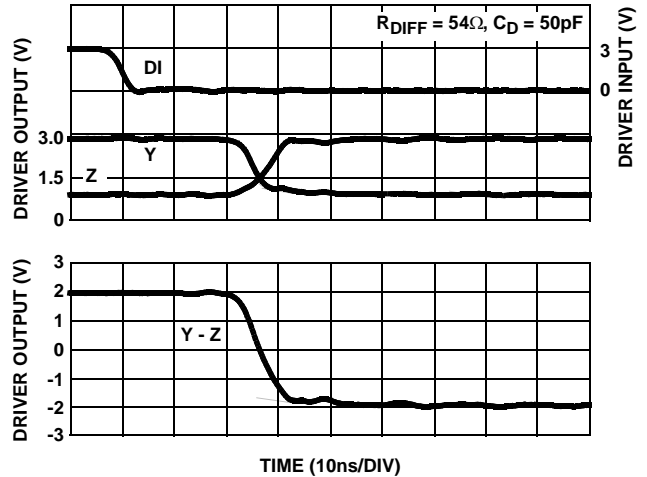

FIGURE 23. DRIVER WAVEFORMS, HIGH TO LOW (ISL3295E, ISL3298E)

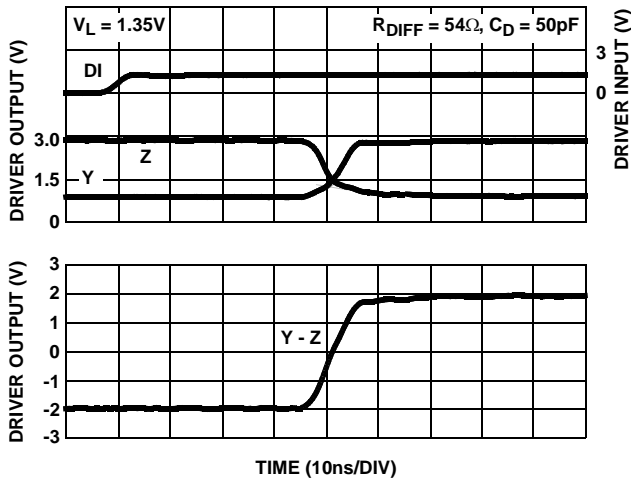

FIGURE 24. DRIVER WAVEFORMS, LOW TO HIGH (ISL3295E, ISL3298E)

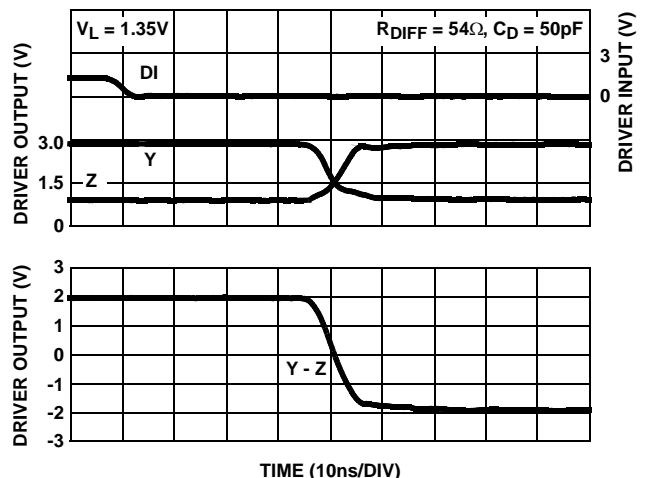

FIGURE 25. DRIVER WAVEFORMS, HIGH TO LOW (ISL3295E, ISL3298E)

Die Characteristics

SUBSTRATE AND TDFN THERMAL PAD POTENTIAL (POWERED UP):

GND

TRANSISTOR COUNT:

516

PROCESS:

Si Gate BiCMOS

Small Outline Transistor Plastic Packages (SOT23-6)

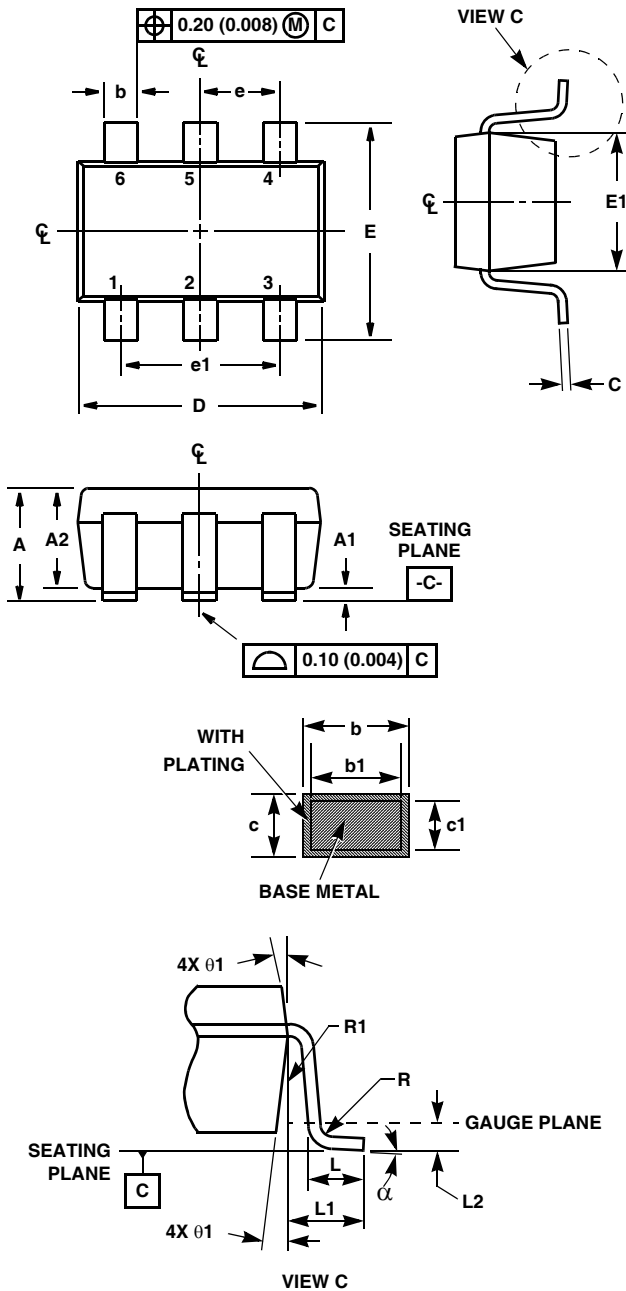

P6.064

6 LEAD SMALL OUTLINE TRANSISTOR PLASTIC PACKAGE

SYMBOL	INCHES		MILLIMETERS		NOTES
	MIN	MAX	MIN	MAX	
A	0.036	0.057	0.90	1.45	-
A1	0.000	0.0059	0.00	0.15	-
A2	0.036	0.051	0.90	1.30	-
b	0.012	0.020	0.30	0.50	-
b1	0.012	0.018	0.30	0.45	-
c	0.003	0.009	0.08	0.22	6
c1	0.003	0.008	0.08	0.20	6
D	0.111	0.118	2.80	3.00	3
E	0.103	0.118	2.60	3.00	-
E1	0.060	0.068	1.50	1.75	3
e	0.0374 Ref		0.95 Ref		-
e1	0.0748 Ref		1.90 Ref		-
L	0.014	0.022	0.35	0.55	4
L1	0.024 Ref.		0.60 Ref.		-
L2	0.010 Ref.		0.25 Ref.		-
N	6		6		5
R	0.004	-	0.10	-	-
R1	0.004	0.010	0.10	0.25	-
α	0°	8°	0°	8°	-

Rev. 3 9/03

NOTES:

1. Dimensioning and tolerance per ASME Y14.5M-1994.
2. Package conforms to EIAJ SC-74 and JEDEC MO178AB.
3. Dimensions D and E1 are exclusive of mold flash, protrusions, or gate burrs.
4. Footlength L measured at reference to gauge plane.
5. "N" is the number of terminal positions.
6. These Dimensions apply to the flat section of the lead between 0.08mm and 0.15mm from the lead tip.
7. Controlling dimension: MILLIMETER. Converted inch dimensions are for reference only

